

Confidea[®]

Wireless conference system



Table of Content

FAMILY CONCEPT

DELEGATE EQUIPMENT

Confidea DD/CD V1.0	11
Confidea 2D2D V1.0	13
Confidea DV V1.0	15
Confidea CV V1.0	17
Confidea DI/CI V1.0	19
Confidea 2D2I V1.0	21
Confidea DIV/CIV V1.0	23
MIC38SL V1.0	25
Confidea BP V1.0	26

INTERPRETER EQUIPMENT

ID2500 V2	30
ID5500 V2.1	32

CENTRAL EQUIPMENT

Confidea WCAP+ V1.0	36
Confidea APPS V1.0	40
CE2500/B V1.0	41
CPU5500 V2	43
SPL5525 V2	45

ACCESSORIES

Confidea CHT V1.0	48
Confidea CHC V1.0	50
Confidea BPC V1.0	52
TEL151 V2	53
TEL10 V2	54

Family Concept

Delegate Equipment



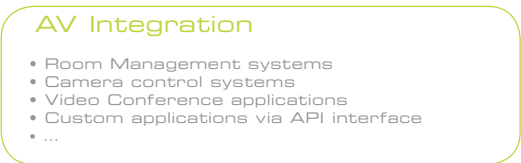
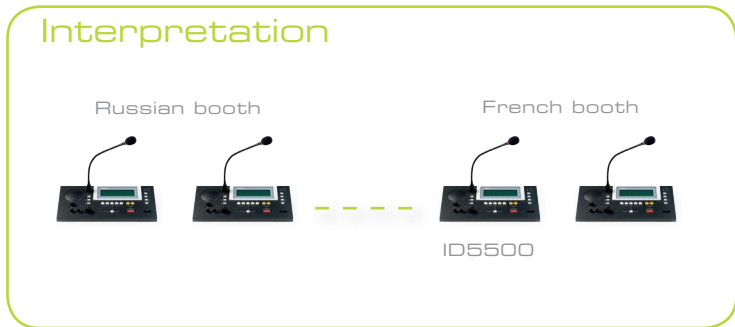

Confidea DD/CD

WIRELESS DISCUSSION UNIT

Art. 71.98.0001 / 71.98.0011



Confidea DD



Confidea CD

Description

The Confidea wireless unit combines a slim, contemporary design, excellent intelligibility and ease of use with a robust and reliable wireless connection which sets it apart from traditional wireless systems.

It allows delegates of a conference to speak, request-to-speak and listen to the speaker.

The units are equipped with a microphone On/Off or request-to-speak button and have two headphone outputs with a single volume control.

The chairman unit comes with an additional priority, next-in-line and system volume adjustment button.

Battery management is crucial using a wireless conference system. Therefore Confidea units combine a smart power management with an easy to replace removeable Lithium-ion battery pack. This results in a controllable and flexible recharging shedule. (Confidea BP, to be ordered separately)

A screw lock connector is provided to connect a removable microphone which is immune against GSM disturbances (MIC 38SL, to be ordered separately).

To prevent eavesdropping and unauthorized access, the Confidea® wireless system and the discussion units have a digital encryption mechanism to keep information of the meeting confidential.

Controls and Features

- Built-in high quality loudspeaker which is automatically muted when the microphone is active, to prevent acoustic feedback.
- Microphone On/Off or request-to-speak button with two signalling LEDs
- Two headphone outputs
- One headphone volume adjustment
- The chairman version (CD) comes with a priority, next-in-line and system volume adjustment button

Status Control

- Red battery status LED
4 h remaining : 1 Hz blinking
2h remaining : 2 Hz blinking
1h remaining : 4 Hz blinking
- Blue out of range status LED
Off : connection established
Blinking : searching connection
On : out of range, shutdown after 2 min.

Connectivity

- Two 3.5 mm jack plugs for headphones
- Battery pack connection
- Screw lock socket to connect removable microphone

Specifications

Technical Data	
Audio Quality	16 bit, 32 kHz
Audio delay	max 20 ms
Power Supply	Battery pack
Dimensions	230(w), 130(h), 60(d))
Weight (g)	480
Color	RAL9011
Part number	Confidea DD 71.98.0001 Confidea CD 71.98.0011

Accessories

- Removeable microphone
MIC38SL 71.98.0050
- Battery pack
Confidea BP 71.98.0042
- Transport case
Confidea CHC 71.98.0044
- Headphones
TEL151 71.04.0151

Confidea 2D2D

WIRELESS DUAL DISCUSSION UNIT

Art. 71.98.0022

Description

The Confidea wireless unit combines a slim, contemporary design, excellent intelligibility and ease of use with a robust and reliable wireless connection which sets it apart from traditional wireless systems.

It allows two delegates of a conference to speak, request-to-speak and listen to the speaker.

The units are equipped with two microphone On/Off or request-to-speak button and two separate headphone volume control buttons.

This dual use unit has two microphone buttons for individual microphone activation and individual delegate identification use for delegate management, speech time and camera tracking systems.

Battery management is crucial using a wireless conference system. Therefore Confidea units combine a smart power management with an easy to replace removeable Lithium-ion battery pack. This results in a controllable and flexible recharging schedule. (Confidea BP, to be ordered separately)

A screw lock connector is provided to connect a removable microphone which is immune against GSM disturbances (MIC 38SL, to be ordered separately).

To prevent eavesdropping and unauthorized access, the Confidea® wireless system and the discussion units have a digital encryption mechanism to keep information of the meeting confidential.



Confidea 2D2D

Controls and Features

- Built-in high quality loudspeaker which is automatically muted when the microphone is active, to prevent acoustic feedback.
- Microphone On/Off or request-to-speak button with two signalling LEDs
- Two headphone outputs
- Two headphone volume adjustments

Connectivity

- Two 3.5 mm jack plugs for headphones
- Battery pack connection
- Screw lock socket to connect removable microphone

Status Control

- Red battery status LED
4 h remaining : 1 Hz blinking
2h remaining : 2 Hz blinking
1h remaining : 4 Hz blinking
- Blue link status LED
Off : connection established
Blinking : low link quality
- Blue link status LED + Microphone LED
Blinking : out of range, shutdown after 2 min.

Specifications

Technical Data	
Audio quality	16 bit digital
Headphone load impedance	> 32 ohm < 1k ohm
Output power	16.5 mW / 32 ohm
Power Supply	Battery pack
Dimensions	230(w), 130(h), 60(d)
Weight (g)	460
Color	RAL9011
Part number	Confidea D2D 71.98.0022

Accessories

- Removeable microphone
MIC38SL 71.98.0050
- Battery pack
Confidea BP 71.98.0042
- Transport case
Confidea CHC 71.98.0044
- Headphones
TEL151 71.04.0151

Confidea DV

WIRELESS DELEGATE VOTING UNIT

Art. 71.98.0002



Confidea DV

Description

The Confidea wireless unit combines a slim, contemporary design, excellent intelligibility and ease of use with a robust and reliable wireless connection which sets it apart from traditional wireless systems.

It allows the delegate of a conference to speak, request-to-speak, listen to the speaker and vote

The units are equipped with a microphone On/Off or request-to-speak button, two headphone outputs with a single volume control and three voting buttons with a voting result information display.

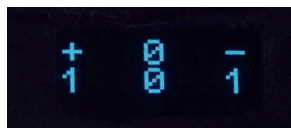

In combination with the access point (Confidea WCAP) and a chairman unit (Confidea CV) basic voting sessions can be performed without the need of a central control unit. The voting session is controlled via the chairman voting control buttons, the results of the session are displayed on the OLED information display of each unit within the system.

Battery management is crucial using a wireless conference system. Therefore Confidea units combine a smart power management with an easy to replace removeable Lithium-ion battery pack. This results in a controllable and flexible recharging schedule. (Confidea BP, to be ordered separately)

A screw lock connector is provided to connect a removable microphone which is immune against GSM disturbances (MIC 38SL, to be ordered separately).

To prevent eavesdropping and unauthorized access, the Confidea® wireless system and the discussion units have a digital encryption mechanism to keep information of the meeting confidential.

Controls and Features

- Three voting buttons
- OLED voting result display
- Built-in high quality loudspeaker which is automatically muted when the microphone is active, to prevent acoustic feedback.
- Microphone On/Off or request-to-speak button with two signalling LEDs
- Two headphone outputs
- One headphone volume adjustment

Status Control

- Red battery status LED
4 h remaining : 1 Hz blinking
2h remaining : 2 Hz blinking
1h remaining : 4 Hz blinking
- Blue link status LED
Off : connection established
Blinking : low link quality
- Blue link status LED + Microphone LED
Blinking : out of range, shutdown after 2 min.

Connectivity

- Two 3.5 mm jack plugs for headphones
- Battery pack connection
- Screw lock socket to connect removable microphone

Specifications

Technical Data	
Audio quality	16 bit digital
Headphone load impedance	> 32 ohm < 1k ohm
Output power	16.5 mW / 32 ohm
Power Supply	Battery pack
Dimensions	230(w), 130(h), 60(d)
Weight (g)	460
Color	RAL9011
Part number	Confidea DV 71.98.0002

Accessories

- Removeable microphone
MIC38SL 71.98.0050
- Battery pack
Confidea BP 71.98.0042
- Transport case
Confidea CHC 71.98.0044
- Headphones
TEL151 71.04.0151

Confidea CV

WIRELESS CHAIRMAN VOTING UNIT

Art. 71.98.0012



Confidea CV

Description

The Confidea wireless unit combines a slim, contemporary design, excellent intelligibility and ease of use with a robust and reliable wireless connection which sets it apart from traditional wireless systems.

It allows the chairman of a conference to speak, request-to-speak, listen to the speaker and vote

The units are equipped with a microphone On/Off or request-to-speak button, two headphone outputs with a single volume control and three voting buttons with a voting result information display.

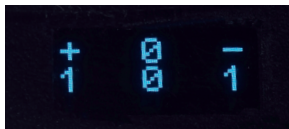

To guide the meeting in an easy way the chairman has the ability to use its priority, next-in-line; system volume adjustment and voting session control buttons.



In a stand-alone configuration of an access point (Confidea WCAP) and several delegate units (Confidea DV) basic voting sessions can be performed without the need of a central control unit. The voting session is controlled via the chairman voting control buttons, the results of the session are displayed on the OLED information display of each unit within the system.

Battery management is crucial using a wireless conference system. Therefore Confidea units combine a smart power management with an easy to replace removeable Lithium-ion battery pack. This results in a controllable and flexible recharging schedule. (Confidea BP, to be ordered separately)

A screw lock connector is provided to connect a removable microphone which is immune against GSM disturbances (MIC 38SL, to be ordered separately).

To prevent eavesdropping and unauthorized access, the Confidea® wireless system and the discussion units have a digital encryption mechanism to keep information of the meeting confidential.

Controls and Features

- Three voting buttons
- OLED voting result display
- Built-in high quality loudspeaker which is automatically muted when the microphone is active, to prevent acoustic feedback.
- Microphone On/Off or request-to-speak button with two signalling LEDs
- Two headphone outputs
- One headphone volume adjustment

Status Control

- Red battery status LED
4 h remaining : 1 Hz blinking
2h remaining : 2 Hz blinking
1h remaining : 4 Hz blinking
- Blue link status LED
Off : connection established
Blinking : low link quality
- Blue link status LED + Microphone LED
Blinking : out of range, shutdown after 2 min.

Connectivity

- Two 3.5 mm jack plugs for headphones
- Battery pack connection
- Screw lock socket to connect removable microphone

Specifications

Technical Data	
Audio quality	16 bit digital
Headphone load impedance	> 32 ohm < 1k ohm
Output power	16.5 mW / 32 ohm
Power Supply	Battery pack
Dimensions	230(w), 130(h), 60(d)
Weight (g)	480
Color	RAL9011
Part number	Confidea CV 71.98.0012

Accessories

- Removeable microphone
MIC38SL 71.98.0050
- Battery pack
Confidea BP 71.98.0042
- Transport case
Confidea CHC 71.98.0044
- Headphones
TEL151 71.04.0151

Confidea DI/CI

WIRELESS CHANNEL SELECTOR UNIT

Art. 71.98.0003 / 71.98.0013



Confidea DI



Confidea CI

Description

The Confidea wireless unit combines a slim, contemporary design, excellent intelligibility and ease of use with a robust and reliable wireless connection which sets it apart from traditional wireless systems.

It allows a delegate/chairman of a conference to speak, request-to-speak and listen to the speaker or their preferred available language.

The units are equipped with a microphone On/Off or request-to-speak button and single channel selector including separate OLED display indicating chosen channel number, abbreviated channel name and headphone volume.

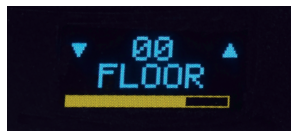

The chairman unit comes with an additional priority, next-in-line and system volume adjustment button.

The Confidea DI/CI units have the capability of receiving up to 40 translation channels. Up to 8 microphones can be open at the same time.

Battery management is crucial using a wireless conference system. Therefore Confidea units combine a smart power management with an easy to replace removeable Lithium-ion battery pack. This results in a

controllable and flexible recharging schedule. (Confidea BP, to be ordered separately)

A screw lock connector is provided to connect a removable microphone which is immune against GSM disturbances (MIC 38SL, to be ordered separately).

To prevent eavesdropping and unauthorized access, the Confidea® wireless system and the discussion units have a digital encryption mechanism to keep information of the meeting confidential.

Controls and Features

- Built-in high quality loudspeaker which is automatically muted when the microphone is active, to prevent acoustic feedback.
- Microphone On/Off or request-to-speak button with two signalling LEDs
- Two headphone outputs
- One headphone volume adjustment
- One channel Up/Down adjustment
- OLED channel and headphone volume information display
- The chairman version (CI) comes with a priority, next-in-line and system volume adjustment button

Status Control

- Red battery status LED
4 h remaining : 1 Hz blinking
2h remaining : 2 Hz blinking
1h remaining : 4 Hz blinking
- Blue link status LED
Off : connection established
Blinking : low link quality
- Blue link status LED + Microphone LED
Blinking : out of range, shutdown after 2 min.

Connectivity

- Two 3.5 mm jack plugs for headphones
- Battery pack connection
- Screw lock socket to connect removable microphone

Specifications

Technical Data	
Audio quality	16 bit digital
Headphone load impedance	> 32 ohm < 1k ohm
Output power	16.5 mW / 32 ohm
Power Supply	Battery pack
Dimensions	230(w), 130(h), 60(d)
Weight (g)	460
Color	RAL9011
Part number	Confidea DI 71.98.0003 Confidea CI 71.98.0013

Accessories

- Removeable microphone
MIC385L 71.98.0050
- Battery pack
Confidea BP 71.98.0042
- Transport case
Confidea CHC 71.98.0044
- Headphones
TEL151 71.04.0151

Confidea 2D2I

WIRELESS DUAL CHANNEL SELECTOR UNIT

Art. 71.98.0024

Description

The Confidea wireless unit combines a slim, contemporary design, excellent intelligibility and ease of use with a robust and reliable wireless connection which sets it apart from traditional wireless systems.

It allows two delegates of a conference to speak, request-to-speak and listen to the speaker or their preferred available language.

The units are equipped with two microphone On/Off or request-to-speak buttons and two individually controllable channel selectors including separate OLED displays indicating chosen channel number, abbreviated channel name and headphone volume.

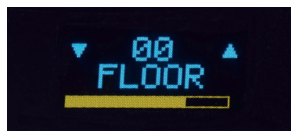

This dual use unit has two microphone buttons for individual microphone activation and individual delegate identification used for delegate management, speech time and camera tracking systems.

The Confidea 2D2I units have the capability of receiving up to 16 translation channels. Up to 8 microphones can be open at the same time.

Battery management is crucial using a wireless conference system. Therefore Confidea units combine a smart power management with an easy to replace removable Lithium-ion battery pack. This results in a controllable and flexible recharging schedule. (Confidea BP, to be ordered separately)

A screw lock connector is provided to connect a removable microphone which is immune against GSM disturbances (MIC 38SL, to be ordered separately).



Confidea 2D2I

To prevent eavesdropping and unauthorized access, the Confidea® wireless system and the discussion units have a digital encryption mechanism to keep information of the meeting confidential.

Controls and Features

- Built-in high quality loudspeaker which is automatically muted when the microphone is active, to prevent acoustic feedback.
- Two Microphone On/Off or request-to-speak buttons with two signalling LEDs
- Two headphone outputs
- Two headphone volume adjustments
- Two Channel Up/Down adjustments
- Two OLED channel and volume information displays

Connectivity

- Two 3.5 mm jack plugs for headphones
- Battery pack connection
- Screw lock socket to connect removable microphone

Status Control

- Red battery status LED
4 h remaining : 1 Hz blinking
2h remaining : 2 Hz blinking
1h remaining : 4 Hz blinking
- Blue link status LED
Off : connection established
Blinking : low link quality
- Blue link status LED + Microphone LED
Blinking : out of range, shutdown after 2 min.

Specifications

Technical Data	
Audio quality	16 bit digital
Headphone load impedance	> 32 ohm < 1k ohm
Output power	16.5 mW / 32 ohm
Power Supply	Battery pack
Dimensions	230(w), 130(h), 60(d))
Weight (g)	480
Color	RAL9011
Part number	Confidea D2I 71.98.0024

Accessories

- Removeable microphone
MIC38SL 71.98.0050
- Battery pack
Confidea BP 71.98.0042
- Transport case
Confidea CHC 71.98.0044
- Headphones
TEL151 71.04.0151

Confidea DIV/CIV

WIRELESS VOTING UNIT WITH CHANNEL SELECTOR

Art. 71.98.0004 / 71.98.0014



Confidea DIV



Confidea CIV

Description

The Confidea wireless unit combines a slim, contemporary design, excellent intelligibility and ease of use with a robust and reliable wireless connection which sets it apart from traditional wireless systems.

It allows a delegate/chairman of a conference to speak, request-to-speak and listen to the speaker or their preferred available language.

The units are equipped with a microphone On/Off or request-to-speak button, a single channel selector and five voting buttons.



The chairman unit comes with an additional priority, next-in-line and system volume adjustment button.

The Confidea units have the capability of receiving up to 16 translation channels. Up to 8 microphones can be open at the same time.

Using the Televic software suite voting sessions can be initiated. Features like voting agenda, voting setup and result logging are included. Results of a voting session can be displayed on screens using the visualisation module of the software suite.

Battery management is crucial using a wireless conference system. Therefore Confidea units combine a smart power management with an easy to replace removeable Lithium-ion battery pack. This results in a controllable and flexible recharging schedule. (Confidea BP, to be ordered separately)

A screw lock connector is provided to connect a removable microphone which is immune against GSM disturbances (MIC 38SL, to be ordered separately).

To prevent eavesdropping and unauthorized access, the Confidea® wireless system and the discussion units have a digital encryption mechanism to keep information of the meeting confidential.

Controls and Features

- Built-in high quality loudspeaker which is automatically muted when the microphone is active, to prevent acoustic feedback.
- Microphone On/Off or request-to-speak button with two signalling LEDs
- Two headphone outputs
- One headphone volume adjustment
- Channel Up/Down adjustment
- OLED channel and volume information display
- Five voting buttons
- The chairman version (CIV) comes with a priority, next-in-line and system volume adjustment button

Status Control

- Red battery status LED
4 h remaining : 1 Hz blinking
2h remaining : 2 Hz blinking
1h remaining : 4 Hz blinking
- Blue link status LED
Off : connection established
Blinking : low link quality
- Blue link status LED + Microphone LED
Blinking : out of range, shutdown after 2 min.

Connectivity

- Two 3.5 mm jack plugs for headphones
- Battery pack connection
- Screw lock socket to connect removable microphone

Specifications

Technical Data	
Audio quality	16 bit digital
Headphone load impedance	> 32 ohm < 1k ohm
Output power	16.5 mW / 32 ohm
Power Supply	Battery pack
Dimensions	230(w), 130(h), 60(d)
Weight (g)	460
Color	RAL9011
Part number	Confidea DIV 71.98.0004 Confidea CIV 71.98.0014

Accessories

- Removeable microphone MIC385L 71.98.0050
- Battery pack Confidea BP 71.98.0042
- Transport case Confidea CHC 71.98.0044
- Headphones TEL151 71.04.0151

MIC38SL

REMOVEABLE MICROPHONE

Art. 71.98.0050



Description

The removeable goosneck microphone is equipped with a screwlock connector for easy connection to the different Confidea units.

Its uni-directional response results in optimal performance even in noisy conditions.

Another important characteristic is the very low susceptibility to interference from mobile phones.

Specifications

Technical Data	
Pick-up pattern	Cardioid
Frequency response	50 Hz to 20 kHz
Sensitivity (1kHz) (free field, no load)	8 mV/Pa ± 2,5 dB
Nominal impedance	1kΩ
Min. Terminating impedance	5kΩ
Equivalent noise level	
A-weighted (DIN IEC 651)	26 dB
CCIR-weighted (CCIR 468-3)	36 dB
Max. SPL (1kHz)	133 dB
Connection	screwlock
Length	380 mm
Weight	±68g
Finish	Matt black, scratch resistant
Part Number	71.98.0050

Confidea BP

BATTERY PACK

Art. 71.98.0042



Description

The high capacity Lithium-ion rechargeable battery pack provides power to the wireless Confidea units.

Lithium-ion rechargeable cells have a long lifespan as they do not have charging degradation issues associated with other rechargeable battery types.

The smart battery pack is monitored and controlled via a built-in microcontroller which monitors the recharging process and prevents overloading.

Fully loading an empty battery takes about 4h and guarantees an autonomy of 20h for typical use.

At the bottom of the battery pack a test button can be pushed to check the remaining charge which is visualised via a led bar for about 3 seconds.

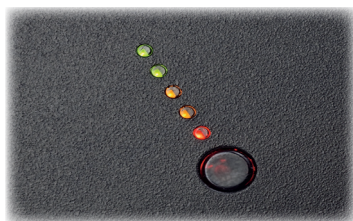

After the remaining charge indication the battery status is visualised. The status code is visualised with a combination of active leds.

Controls and Features

- Battery status LED
- Power adapter connected LED
- Charging LED
- Push-to-test button
- LED bar for capacity and status indication

Accessories

- Charging tray :
Confidea CHT 71.98.0043
- Battery charger :
Confidea BPC 71.98.0040

Specifications

Technical Data	
Output voltage	7.2 VDC
Capacity	6600 mAh
Autonomy	20 h
Charging time	4 h
Dimensions (mm)	170 (w), 75 (h), 25 (d)
Weight (g)	377
Color	RAL9011
Part Number	71.98.0042



Interpreter Equipment



Description

The ID2500 Digital Interpreter Desk features a unique and attractive design. It is supplied in an attractively designed elegant housing, and conforms to all relevant international norms.

The ID2500 features easy and intuitive operation and can accommodate the floor language plus 4, 8 or 28 languages. Up to 8 interpreter desks can be installed per booth. An integrated graphical LCD display with backlighting indicates information relevant to the interpreter.

Interpreters can easily select the incoming languages of their choice by using the 3 relay preset buttons with red indicator LED. These buttons are easily programmed by pressing and holding the relay preset button and cycling through the available language channels on the LCD display with the up and down controls. Releasing the relay-preset button programmes the selected language.

Interpreters get an indication on the graphical LCD display of the quality of the incoming languages. This way they can distinguish between a direct and an indirect interpretation, thereby avoiding indirect interpretations whenever possible.

Controls and Features

- Integrated electret condenser gooseneck microphone, with built-in illuminator ring.
- Integrated loudspeaker with rotary volume control and up and down channel selector. The loudspeaker is activated when no interpreter microphones in the booth are active.
- Headphones rotary volume, bass and treble controls.
- Up and down controls for selection of relay preset languages and Outgoing Channel B



- 3 relay-preset buttons for selection of incoming languages.
- Outgoing Channel A and Outgoing Channel B selection keys with red 'engaged' LED indicators.
- The interpreter can program the Outgoing Channel B individually.
- Graphical 122 x 32 dots LCDisplay with backlighting, used for indicating
 - Incoming languages
 - Interpretation quality (Floor +, -)
 - Outgoing channels
 - Status of loudspeaker
 - Set-up mode (not accessible in normal operation mode)
- Large Red Microphone On/Off button with red LED
- Grey Mute button
- Message button with acknowledge LED indicator for various types of calls.

Accessories

- Digital bus cable, RJ45 24AWG:
2m (ICC5/2 71.60.4002)
5m (ICC5/5 71.60.4005)
10m (ICC5/10 71.60.4010)
20m (ICC5/20 71.60.4020)
Standard Ethernet patch cable AWG26 cannot be used!
- Headphones TEL10 (71.04.1214)
- Headphones TEL151 (71.04.0151)
- Chip Card CC5500 (71.43.2000)

Connectivity

- Two RJ 45 connectors for separate loop through cabling of the TMS digital data bus (IN and OUT), max 20 units/bus
- Two 3.5 mm jack plug for headphones
- One 3.5 mm jack plug for headset connection (microphone and headphone combination)



Technical Data

Standards	IEC 268, IEC914, ISO4043
Frequency response	100-14000 Hz
Microphone pick-up pattern	cardioid
Length microphone	380 mm
Headphone output power	1.7 V at 90 mW
Headset input sensitivity	6.3 mV
Headset input impedance	$\geq 1k\Omega$ (at 1 kHz)
S/N at headphone output	> 68 dBA
Power Supply	48 VDC, supplied by CE2500
Power consumption	2.5 W
Operating temperature	+5 ... +50 °C
Dimensions	150(w), 80(h), 185(d) mm
Weight (g)	± 0.7 kg
Color	Charcoal Pantone Black 7C
Housing	Recyclable ABS
Part Number	71.60.2103 (Delegate) 71.60.2104 (Chairman)



Description

The ID5500 Interpreter Desk features a unique and attractive design. It is supplied in a professional all metal housing, and conforms to all relevant international norms. All interpreter desks are identical and interchangeable in case of malfunction. A malfunction in one interpreter desk has no influence on the operation of any other interpreter desk in the system.

The ID5500 offers easy and intuitive operation and can accommodate the floor language plus 58 languages. Up to 15 interpreter desks can be installed per booth. An integrated alphanumeric LCD display indicates information relevant to the interpreter.

Interpreters can easily select the incoming languages of their choice by using the 5 relay preset buttons with red indicator LED. These buttons are easily programmed by pressing and holding the relay preset button and cycling through the available language channels on the LCD display with the up and down controls. Releasing the relay preset button programs the selected language. The relay preset is activated by pressing the white relay button with green LED indicator.

Interpreters get an indication on the LCD display of the quality of the incoming languages. This way they can distinguish between a direct and an indirect interpretation, thereby avoiding indirect interpretations whenever possible.

Controls and Features

- Removable goose-neck microphone TGM407 with built-in illuminator ring
- Integrated loudspeaker with rotary volume control and up and down channel selector. The loudspeaker is activated when no interpreter desks in the booth are active
- Headphones rotary volume, bass and treble controls.
- Up and down controls for selection of relay preset languages and Outgoing Channel B
- 5 relay preset buttons for selection of incoming languages.
- Relay button for activation of relay interpretation. The relay button has "on/off" and "autofloor" LED indicators
- Yellow Outgoing Channel A and Outgoing Channel B selection keys with red 'engaged' LED indicators. Each interpreter can program the Outgoing Channel B individually

- 64 x 240 dots graphical LCD display with backlighting, used for indicating
 - incoming languages
 - interpretation quality (FL, -1, -2)
 - outgoing channels
 - messages
 - status of loudspeaker + headphones
 - Setup mode (not accessible in normal operation mode)
- Red Microphone On/Off button with two color (green & red) LED bar
- Black Mute button
- Grey Info button with green LED indicator, which lights up when a new message is available. Pressing the info button displays the message on the first two lines of the LCD screen
- Call button with acknowledge LED indicator for various types of calls and for intercom function
- Slow Down button to alert chairman that speakers are talking too fast This functionality requires extra hardware near the chairman (DCSL5500 + 71.67.0040)
- LED indicators to warn interpreter that there is an internal (intercom) or external (phone) call



Connectivity

- 5-pin XLR female connector for removable gooseneck microphone
- 2 RJ45 8-pin connectors (digital bus: IN and OUT)
- 3,5mm jack socket for headphones
- 3,5mm jack socket for external microphone

- Headset socket
- 7-pin DIN connector for headset
- 1 RJ45 8-pin connector for connection to peripheral devices:

Activation of EXT and INT LED on desk via telephone indicator board (71.69.5528)

Driving of 'On-Air' indicator light via driver board (71.69.5522)

Accessories

- Gooseneck microphone TGM407 (included)
- Headphones TEL10
- Lightweight headphones TEL151
- Digital bus cable YPC to interconnect ID5500 Interpreter Desks and to connect to the central unit

YPC1	1m	(71.67.4001)
YPC2	2m	(71.67.4002)
YPC5	3m	(71.67.4005)
YPC10	10m	(71.67.4010)
YPC20	20m	(71.67.4020)

Specifications

Technical Data	
Standards	IEC 914 ISO 2603-latest edition
Mounting	Desktop, flush mounting or semi-flush mounting
Dimensions (mm)	108(h)x 370(w) x 200(d) (without microphone) (h = 510mm with microphone)
Weight (g)	+/- 3.420
Colour	RAL7021 (Matt Black)
Housing	Metal
Part Number	71.64.5044

Central Equipment





Confidea WCAP+

WIRELESS CONFERENCE ACCESS POINT

Art. 71.98.0031



Description

The Confidea Conference Access Point+ is the heart of Televics Confidea® system.

The wireless conference system uses the 2.4 and 5 GHz frequency range, providing a large number of channels to guarantee a reliable wireless link at any time.

The access point has three antennas, two transceiver antennas for diversity and a third antenna that constantly scans the band to identify interference sources. This way, the access point is able to automatically choose a 'clean' frequency resulting in a reliable link.

The data exchange between the access point and the wireless discussion units is digitally protected ensuring a secure system.

A single access point has a range of 30m. This range is extendible adding additional access points.

For basic discussion and voting applications the access point can be used in a stand alone mode, acting as a central control unit.

Simply by browsing to the internal webserver, configuration and setup of the wireless system can be performed. Most common used web browsers are supported (IE, Firefox, Google Chrome)

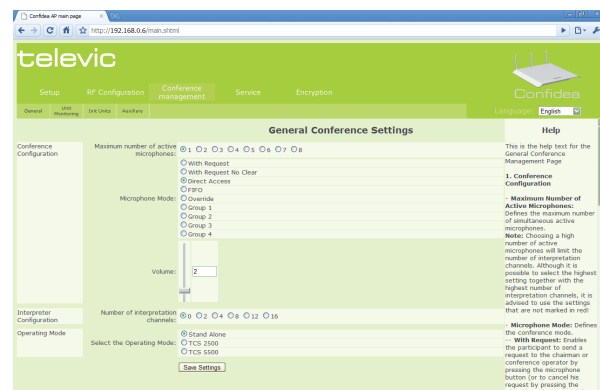

During the meeting status information like radio link quality and the battery condition of each unit can be checked.

Unit Monitoring						
Units Initialized: 2						
Units in Init List: 2						
Summary:						
Test LEDs ON		Test LEDs OFF				
Microphone Number	Serial Number	Status	Link Quality	Battery Status	Version	
0001	0x00000026	connected	fair	12h	01.09.000	
0002	0x000001A1	connected	good		01.09.000	
0003	0x03F00001	connected	fair	18.6h	01.08.002	
0004	0x00000047	connected	fair	0h	01.09.001	

Another great advantage of the WCAP+ is the availability of analog input and output. So for basic systems no additional central equipment is needed to connect the system to an external public address system or to add an external signal to the conference system.



Additionally it is possible to connect the access point to a video conferencing system by activating the distance conferencing (N-1) function preventing feedback.

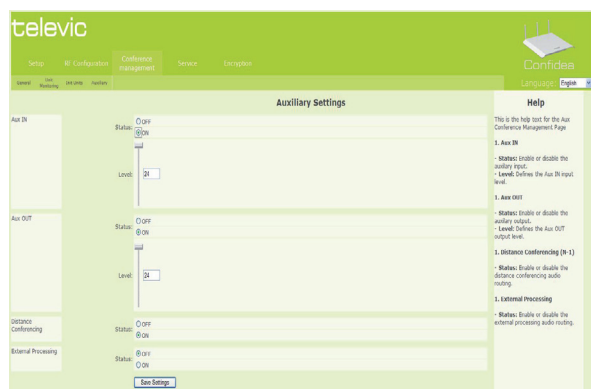

Activating the external processing allows to add external signal processing equipment or a mixing board.

Finally the standalone wireless system can be controlled via the Confidea CS software suite. It offers basic functions for microphone management, synoptic control and voting management.

Simultaneous interpretation and more advanced discussion or voting applications (synoptical view, voting result logging, I/O peripherals...) require connection to a central control unit.

Following the Televic family concept the access point can be connected to any central control unit with the corresponding software suite.

In total the Confidea® system can handle up to 16 translation channels and up to 8 open microphones.

Confidea® can also be used to temporarily or permanently expand an existing wired installation. By connecting the WCAP to the installed Televic central unit, a number of wireless units can be added creating a hybrid conference system.

Connectivity

- Power connector
- RJ45 LAN connection
- RJ45 in from central control unit
- RJ45 out to next access point (if needed)
- 6.3 mm jack balanced analog in
- 6.3 mm jack balanced analog out
- Two overload activity LEDs
- 3 R-SMA antenna connectors

Specifications

Technical Data	
Power Consumption	6 W
Mounting	Table Wall Floorstand
Dimensions (without antennas)	260(w) x 230(h) x 38(d)
Weight (g)	1220
Colour	RAL 7035
Housing	Metal
Part number	71.98.0031

Accessories

- Confidea APPS 71.98.0041
Access point power supply needed in standalone mode
- Digital bus cable, Cat5 24AWG:

2m ICC5/2	71.60.4002
5m ICC5/5	71.60.4005
10m ICC5/10	71.60.4010
20m ICC5/20	71.60.4020
- Confidea CS Software suite

Dimensions

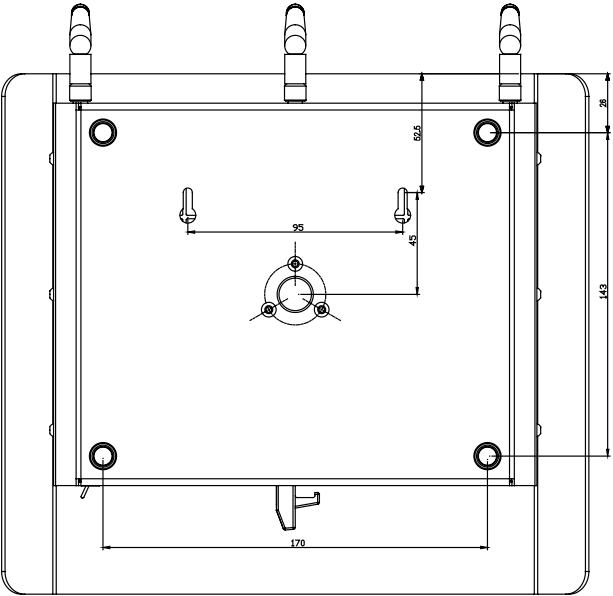
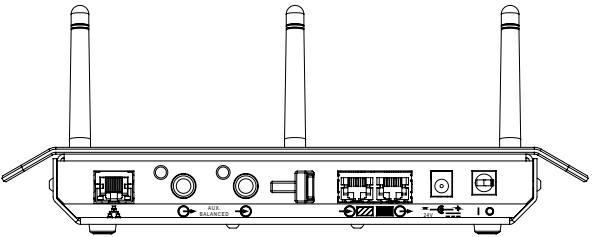
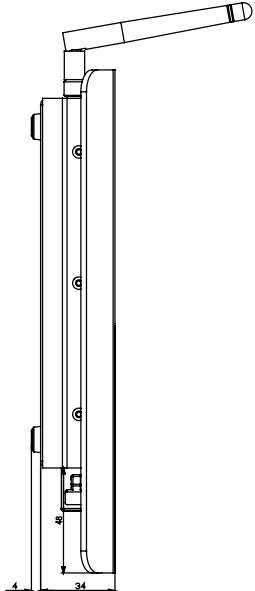
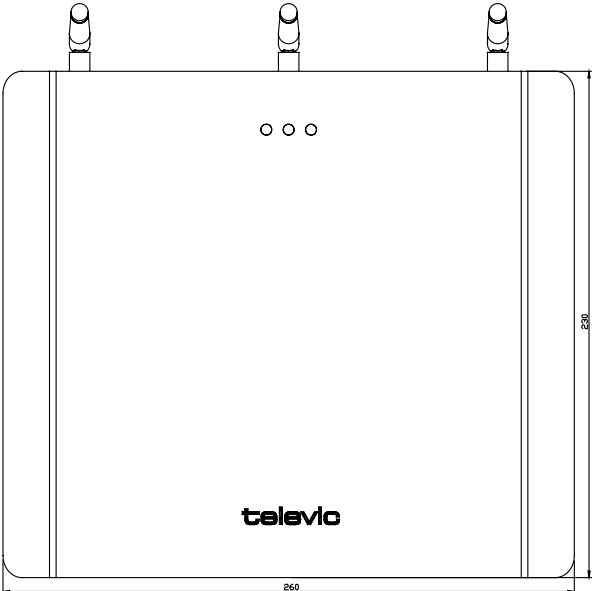

Confidea APPS

ACCESS POINT POWER SUPPLY

Art. 71.98.0041



Description

In standalone configuration, the Confidea Access Point needs to be powered via the access point power supply.

The power supply comes with interchangeable power plugs. (IA, IE, IU and IB) and a cable of 1.5 m

Connections

- DC connector: 5.5x2.1x11mm, C+, Straight

Specifications

Technical Data	
Input	110 - 220 VAC +/- 10% (50 - 60 Hz)
Output	24 VDC, 0.64 A
Dimensions (mm)	40 (w) x 71 (h) x 38.8 (d)
Weight (g)	180
Color	Black
Part number	71.98.0041

Digital Conference and Interpretation Central

Art. 71.60.1005



Description

The CE2500/B central unit is the heart of the TCS2500 digital Conference/Simultaneous Interpretation system. It comes in an all-metal 19" housing for rack or tabletop mounting.

The integrated supply powers delegates and interpreter units on 6 available branches. The central unit controls a max of 50 delegates. (Confidea range, all-in-one integrated panels without badge and ID2500 interpreter desks) The double delegate units (2D2I, 2D2D) are counted as two delegates.

In its basic configuration the Central unit can handle interpreter desks (ID2500) up to 4 translated languages for multilingual debates. Adding additional licenses, the supported number of languages can be increased upto 28.

Two analog inputs allow connection of e.g. wireless microphones, or other classic analog signal sources.

An XLR output can connect to a separate analog system, such as an external power amplifier, or an analog recorder.

An additional 15-pin Dsub connector outputs 6 unbalanced channels to be used for e.g. IR modulator.

All settings for the system are made via the central units local configuration menu.

In case larger systems need to be built the CE2500/B can be upgraded with an additional license (71.96.9105), to support upto 120 units and support delegates units with badge reader.

Connectivity

- 6 RJ45 sockets for 6 branches with up to 20 units
- 2 three-pin XLR F connectors for analog inputs
- 1 three-pin XLR M connector for analog output of floor language, transformer balanced
- 1 Dsub 15-pin, offering 6 unbalanced analog outputs (programmable)
- One 3.5mm jack for headphones (front panel mounted)
- 3 serial ports RS-232 for optional PC, media and camera control

Controls & Features

- Rear mounted mains On/Off switch
- 5 programming buttons + rotary wheel
- Graphical display: 122x32 dots
- Headphone monitoring output

Technical Data

Audio Input	
Aux IN 1,2	XLR-3F, transformer balanced
Input voltage range	max +3 dBu
Input impedance	> 6 k Ω at 1 kHz
Frequency response	100-14000 Hz
Audio Output	
Aux OUT1	XLR-3M, transformer balanced
Output level	max. +8 dBu
Output impedance	\leq 200 Ω
Signal to noise ratio	78 dBA
Frequency response	100-14000 Hz
THD+N	\leq 0.05 % (1.5 dBu)
Aux OUT 2-6	15-pole sub-D, unbalanced
Output level	max. +0 dBu
Output impedance	< 100 Ω at 1 kHz
Signal to noise ratio	max. 83 dBA
Frequency response	100-14000 Hz
THD+N	\leq 0.5 % (1.5 dBu)
Headphone	
Output power	max. 90 mW at 32 Ω
Signal to noise ratio	75 dBA
Frequency response	100-14000 Hz
THD+N	\leq 0.2 % (0 dBu)
Power	
Mains Voltage	110-230V AC 50-60 Hz
Current Consumption	max. 3.5 A (230VAC), max. 7 A (115VAC)
Fuse	3.15 A (230VAC); 7A (115VAC)
Output Voltage	48V (Port 1-6)
Environment usage and dimentions	
Operating temperature	+5 ... +50 $^{\circ}$ C
Fan Noise	48 dBA SPL (1m)
Dimensions (mm)	483 (19"), 132 (3U), 213 (d)
Weight (g)	\pm 6 kg
RoHS Compliant	✓



Description

The CPU 5500 Central Unit is the heart of the Televic TCS 5500 digital conference system. This sophisticated unit can operate in stand-alone mode or with a control PC connected. It allows complete control over all aspects of the conference system: microphone management, simultaneous interpretation, language distribution, voting and audience interaction...

The LAN network connectivity allows to easily integrate the conference system in a networked environment. Communication between the central unit, one or more control PC's, slave PC's and video display PC's can be easily established via LAN cabling and the most commonly used protocol in the world: TCP/IP.

In stand-alone mode, the CPU5500 can provide basic conference management functions, including basic voting. With one or two control PC's (one for the complete system or one for the microphone system and one for the simultaneous interpretation system), even the most advanced applications are possible with the powerful TCS 5500 software modules.

For large installs, a virtually unlimited number of extension units and power supply units can be added to accommodate a virtually unlimited number of participants in the system.

As standard, the CPU5500 comes with 6 analog outputs and 2 analog inputs to connect various analog equipment, such as an infra-red language distribution system, a PA system, a N-1 hybrid coupling, etc...

Front Panel Controls

To allow the user to configure the conference parameters an interface consisting of an LCD display, a jog wheel and selection buttons is integrated in the front of the unit. In addition, 8 status LEDs are provided that visualise some important status levels.



A monitoring loudspeaker is installed behind the front panel allowing the operator to listen to a selectable channel. A 3.5 mm stereo headphone connector allows the operator to bypass the loudspeaker.

Connectivity

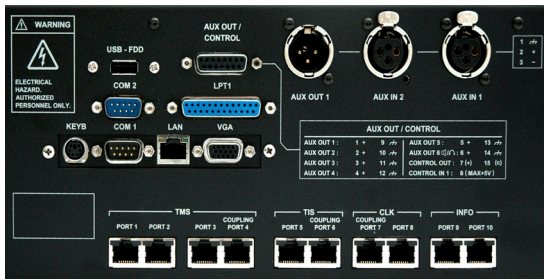

- Four RJ45 connectors for the TMS digital bus, allowing to connect 4 branches of digital interfaces directly to the unit.
- Two RJ45 connectors for the TIS digital bus
- LAN (Ethernet) connector for networking and control communication purposes
- Two RS 232 connectors for camera control, operator desk and bode unit connectivity
- Two RJ45 connectors for clock distribution to Extension Units
- One balanced audio output on XLR
- Two balanced audio inputs on XLR
- Six unbalanced analog outputs on D15
- For service applications
 - USB-FDD connector
 - (S)VGA connector
 - Keyboard connector
 - Parallel port connector

Options

- Digital audio INPUT and OUTPUT (AES/EBU) BNC and Fibre connector (71.61.0071)
- Opto-coupler board for room coupling applications (71.61.0081)

Specifications

Technical Data	
Dimensions (mm)	132.1(h) or 3U 483(w) or 19" 213(d)
Weight (g)	+/- 8.200
Colour	RAL7021 (Matt Black)
Housing	Metal
Part Number	71.64.5004



Description

The Digital Signal Splitter SPL5525 allows connection of 4 chains of mobile delegate units or integrated delegate flush mount panels to a TCS5500 system.

The splitter interfaces are connected to the central unit in daisy chain.

Replacement of a defective splitter interface can be effected without shutting down the system ("hot swapping").

The splitter needs to be powered separately with 48V, supplied by the CPU5500 or by a power supply PS5500

Connectivity

- Four 8-pin shielded RJ45 connectors each for a chain of max. 20 mobile delegate units or integrated delegate panels for flush mount
- Two 8-pin RJ45 connectors for the TMS digital data bus (IN and OUT)
- Two power supply connectors (IN and OUT)

Accessories

- Digital bus cable YPC to interconnect Digital Signal Splitters. This cable is also used to daisy-chain mobile delegate units or integrated delegate flush mount panels, and to connect to the central unit.

YPC1	1m	(71.67.4001)
YPC2	2m	(71.67.4002)
YPC5	3m	(71.67.4005)
YPC10	10m	(71.67.4010)
YPC20	20m	(71.67.4020)

- Fully assembled Power Supply Cable, ready for use:

PW2	2m	(71.67.4102)
-----	----	--------------

- Male power connector for mounting on custom cable.
One connector consists of a base part and a cover part.
(2 sets are included in the delivery):

Base part	(05.70.0153)
Cover part	(05.70.0155)

Specifications

Technical Data	
Dimensions (mm)	85 (h) x 173 (w) x 43.5(d)
Mounting	See drawings on reverse
Weight (g)	+/- 950
Colour	Stainless steel
Housing	Metal
Part Number	71.67.5035

Power Cable Layout

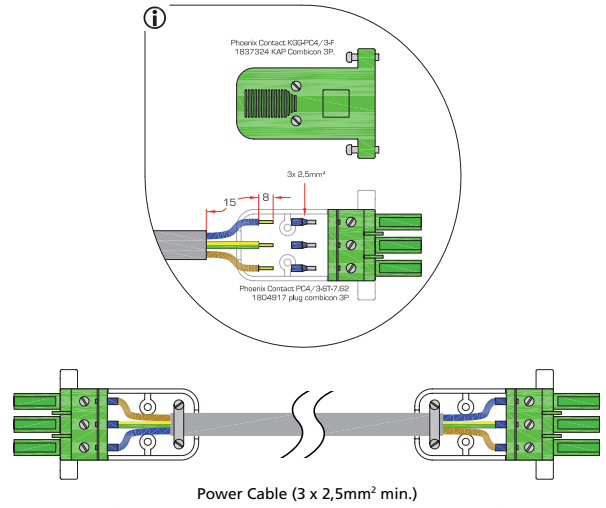

Dimensions

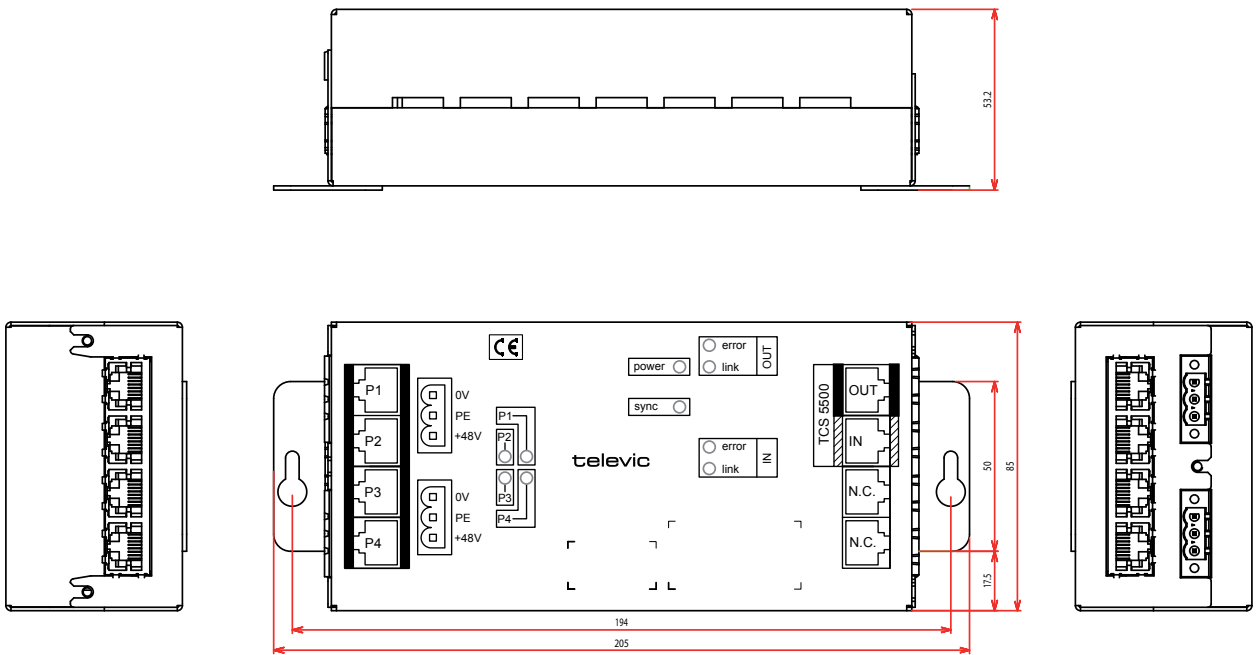

Accessories



Confidea CHT

CHARGING TRAY

Art. 71.98.0043



Description

The Confidea Charging Tray is a rack-mountable device of 3 U high that can recharge 6 Confidea Battery Packs at once.

It has an auto-ranging power supply and a loop- through mains connector.

Maximum 4 chargers can be daisy-chained for 110 VAC regions and 8 for 220 VAC regions.

It is designed for multiple mounting possibilities, having 19" rack, wall or table mounting capabilities.

Features

- Loop-through mains connector
- 6 slots for 1 Confidea Battery Pack each
- 19" rack mountable

Specifications

Technical Data	
Power Supply	110 - 230 VAC +/- 10%
Power consumption	200 W
Dimensions	483(w) x 132.1 (h) x 139.5(d)
Weight (g)	3750
Color	RAL9011
Part Number	71.98.0043

Dimensions

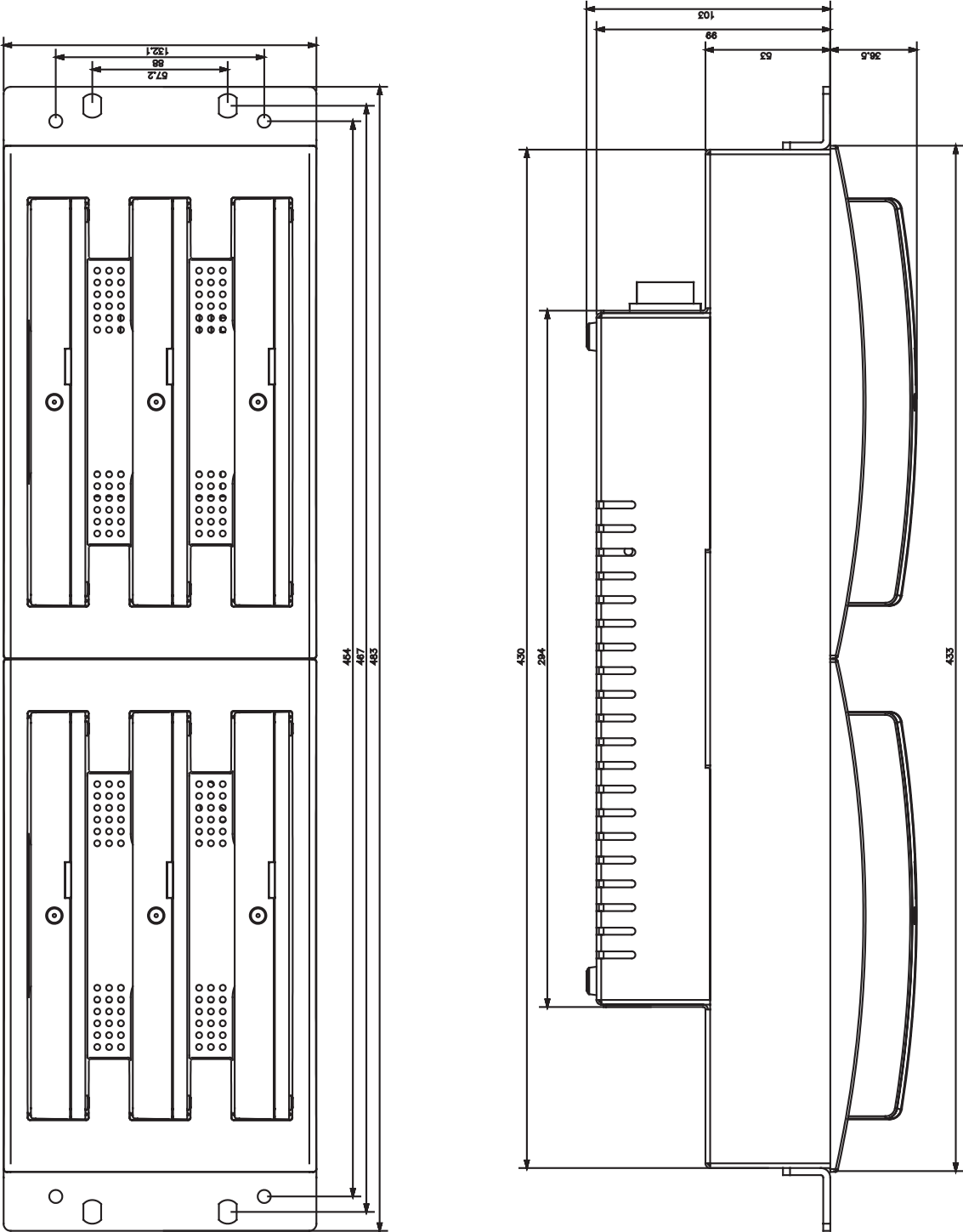

Confidea CHC

CHARGING CASE

Art. 71.98.0044



Features

- Pre-formed foam inlays
- Loop-through mains connector
- Handle for vertical transportation
- 2 handles for horizontal transportation
- Trolley with high quality wheels

Accessories

- Charging tray
Confidea CHT (71.98.0043)

Specifications

Technical Data	
Dimensions (mm)	360(h) x 710(w) x 540(d)
Weight empty (kg)	14.6
Color	Black
Part number	71.98.0044

Description

The Confidea Charging Case accommodates 12 Confidea units with battery pack, 12 microphones, 1 access point and offers the possibility to build-in 2 charging trays (Confidea CHT, to be ordered separately).

The case has been designed for frequent use and safe transportation. It has several handles and a high quality trolley, making it easy and comfortable to move from one place to another.





Confidea BPC

BATTERY PACK CHARGER

Art. 71.98.0040



Description

The battery pack charger can be used to charge a separate battery pack.

If the battery is plugged into the unit, connecting the power adapter will power the complete unit, allowing to use the unit while recharging the battery

The power supply comes with interchangeable power plugs. (IA, IE, IU and IB) and power cable of 1.5 m

Connections

- DC connector: 5.5x2.1x12.5 mm, C+, Straight

Spécifications

Données Techniques	
Primaire	110 - 230 VAC +/- 10% (50 - 60 Hz)
Secondaire	15 VDC, 2 A
Dimensions (mm)	43.5 (w) x 81.5 (h) x 40.5 (d)
Poids (g)	200
Couleur	Noir
Référence	71.98.0040

TEL151

DELEGATE HEADPHONES

Art. 71.04.0151



Connectivity

- 1.5 m connection cable with 3.5 mm mono jack connector.

Accessories

- Pair of hard ear shells for optimal hygiene fitting the TEL151 (13.10.0151)

Description

The TEL151 lightweight dynamic delegate headphones were especially developed for modern conference applications.

Controls and Features

- Excellent intelligibility and speech reproduction
- Adjustable headband
- Rotating ear cups with replaceable foam ear pads for comfort and convenience
- Hard ear shells available as an option
- Light pressure on ear, ensuring hours of comfortable wear
- Single steel core cable, causing minimum disturbance to the user

Specifications

Technical Data	
Transducer principle	Dynamic
Frequency Response)	20 Hz – 20 kHz
Impedance	150 Ohm
Sensitivity	105 dB/mW (+ 3 dB at 1 kHz)
Nominal input	40 mW
Load rating	100 mW
THD	Less than 0.3 % (200 Hz – 2 kHz)
Contact Pressure	Lower than 2.5 N
Weight (g)	+/- 80 g
Part Number	71.04.0151



Connectivity

- 1.5 m connection cable made of steel with 3.5 mm mono jack connector
- Angled 6.3 mm mono jack available upon request

Description

The TEL10 professional dynamic headphones were specifically developed for simultaneous interpretation applications

Controls and Features

- Excellent intelligibility and speech reproduction
- Adjustable steel wire headband.
- Hygienic, smooth ear cups for comfort and convenience
- Light pressure on ear, ensuring hours of comfortable wear
- Single cord, causing minimum disturbance to the user

Specifications

Technical Data	
Transducer principle	Dynamic
Frequency Response	100 Hz – 13 kHz
Impedance	360 Ohm
Sensitivity	98 dB/mW
Load rating	200 mW
THD	< 1 %
Contact Pressure	< 2.5 N
Weight (g)	+/- 90 g
Part Number	71.04.1214: 360 Ohm, avec jack 3,5 mm
	71.04.1215: 360 Ohm, avec jack 6,35 mm